

RISE®



Smart
Moving



SPARTACUS

AUTOMATIC HYDRAULIC BOLLARDS 230 VAC
SEMI AUTOMATIC BOLLARDS
FIXED BOLLARDS



Made in Italy



SPARTACUS 200

Ø 200 mm | H 600-800 mm | Thickness 6 mm



- Automatic hydraulic bollard 230 vac, 600 or 800 mm height, with cylinder thickness 6 mm
- Cathaphoresis treatment and “Graphite Black” painting or cover in brushed AISI316 stainless steel
- Cylinder with built-in LED lights, the control unit can manage 2 bollards at the same time
- Foundation box complying with the EN124 (25T) regulation and independent hydraulic pump for each bollard, laterally positioned in order to avoid any damage in the event of an impact and facilitate the maintenance
- In the event of a power failure, the bollard will remain in the raised position (manual release)
- Heating for the foundation box, buzzer and pressure switch for obstacle detection available as accessories

SPARTACUS 200

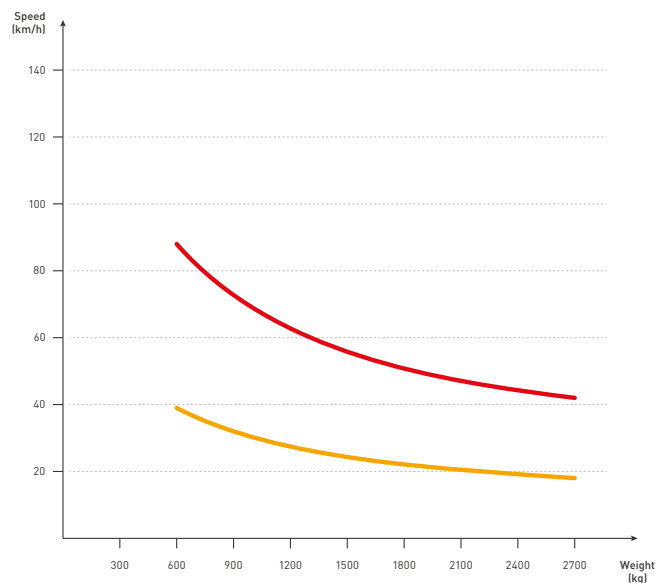

- Impact resistance: 35,000 J
- Breakout resistance: 150,000 J

SPARTACUS 200

Ø 200 mm | H 600-800 mm | Thickness 6 mm

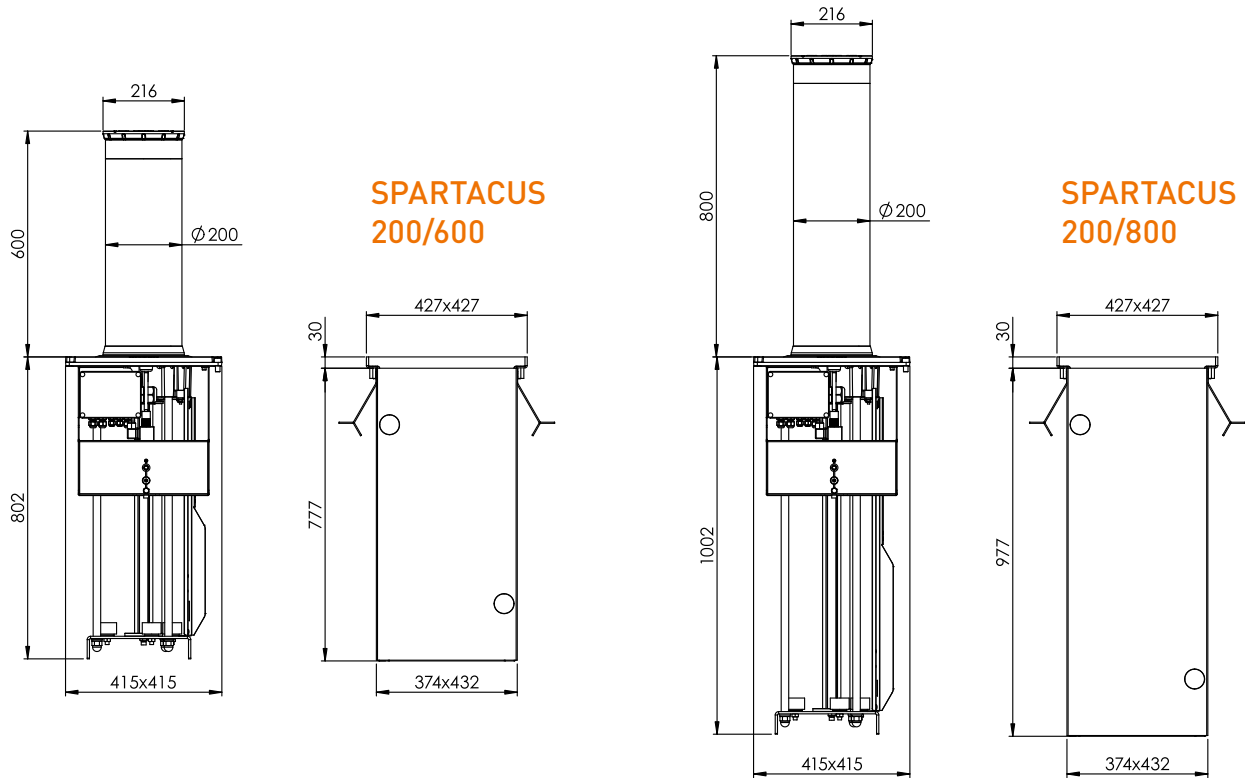

ACCESSORIES:

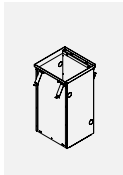

CA200/600
Foundation box for SPARTACUS 200 h 600 mm.

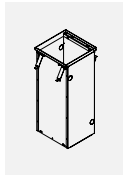

CA200/800
Foundation box for SPARTACUS 200 h 800 mm.



GL.TOP200
Cover for foundation box CA200/600 or CA200/800.



GL.BUZZ
Buzzer.



GL.CABLE12
Cable FG12 12x1.5 mmq.
GL.CABLE16
Cable FG16 16x1.5 mmq.

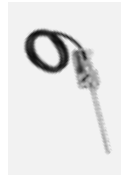

GL.HEAT
Heater for hydraulic bollard, active below 5°C.



GL.PKEY
Personalised release key.



GL.PRES
Pressure switch for obstacle detection.



GL.AL
Device that allows an automatic lowering maneuver.



XLB.AL
Box for up to 4 GL.AL.

TECHNICAL DATA	200/600	200/600 AL	200/800	200/600 I	200/600 I AL	200/800 I
Cylinder height	600 mm		800 mm	600 mm		800 mm
Cylinder diameter	200 mm					
Cylinder thickness	6 mm			6+1.2 mm		
Cylinder material	Steel S355JR			AISI316 stainless steel		
Rising time	3 s		4 s	3 s		4 s
Lowering time	3 s		4 s	3 s		4 s
Power supply	230 Vac - 50/60 Hz [control panel with different voltages available on request]					
Power consumption	500W					
Hydraulic pump	Built-in					
Load index (EN124)	D250 (25 tonnes)					
Operation in case of power failure	Manual release					
Automatic lowering in case of power failure	No	Yes (with GL.AL)	No	Yes (with GL.AL)		No
Obstacle detection during the rising cycle	Optional (GL.PRES)					
Capacitor	25 µF					
Daily cycles	3,500					
MCBF	3,000,000					
Impact resistance	35,000 J					
Breakout resistance	150,000 J					
Operating temperature	-40°C ÷ +60°C [GL.HEAT available as option for temperatures lower than -10°]					
Protection level	IP67					
Weight (without foundation box)	70 kg		78 kg	74 kg		83 kg



SPARTACUS 275

Ø 275 mm | H 600-800 mm | Thickness 6-10 mm



- Automatic hydraulic bollard 230 vac, 600 or 800 mm height, with cylinder thickness 6 or 10 mm
- Cathaphoresis treatment and “Graphite Black” painting or cover in brushed AISI316 stainless steel
- Cylinder with built-in LED lights, the control unit can manage 2 bollards at the same time
- Foundation box complying with the EN124 (40T) regulation and independent hydraulic pump for each bollard, laterally positioned in order to avoid any damage in the event of an impact and facilitate the maintenance
- In the event of a power failure, the bollard will remain in the raised position (manual release)
- Heating for the foundation box, buzzer and pressure switch for obstacle detection available as accessories

SPARTACUS 275

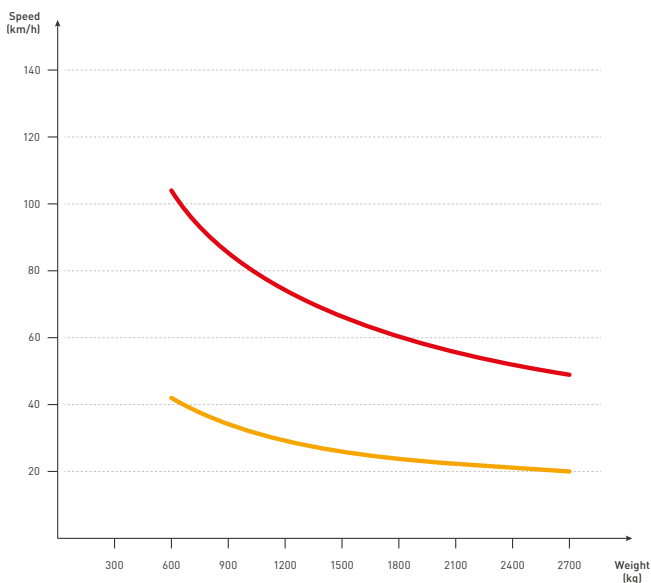

— Impact resistance: 40,000 J
— Breakout resistance: 250,000 J

SPARTACUS 275 R

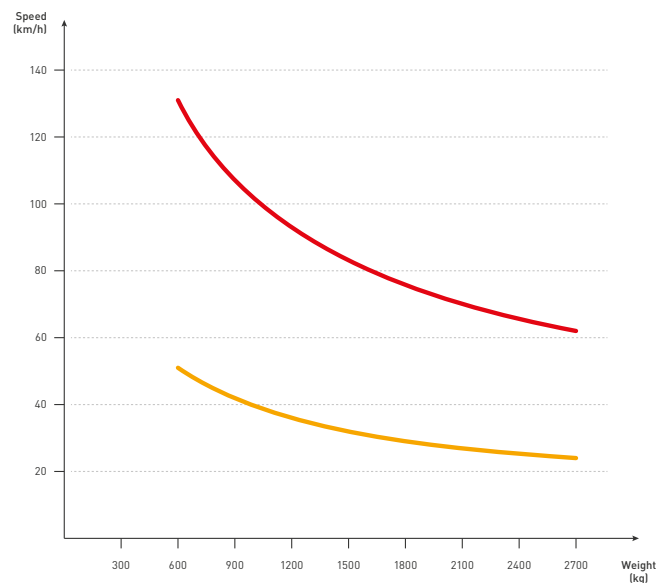

— Impact resistance: 60,000 J
— Breakout resistance: 400,000 J

SPARTACUS 275

Ø 275 mm | H 600-800 mm | Thickness 6-10 mm

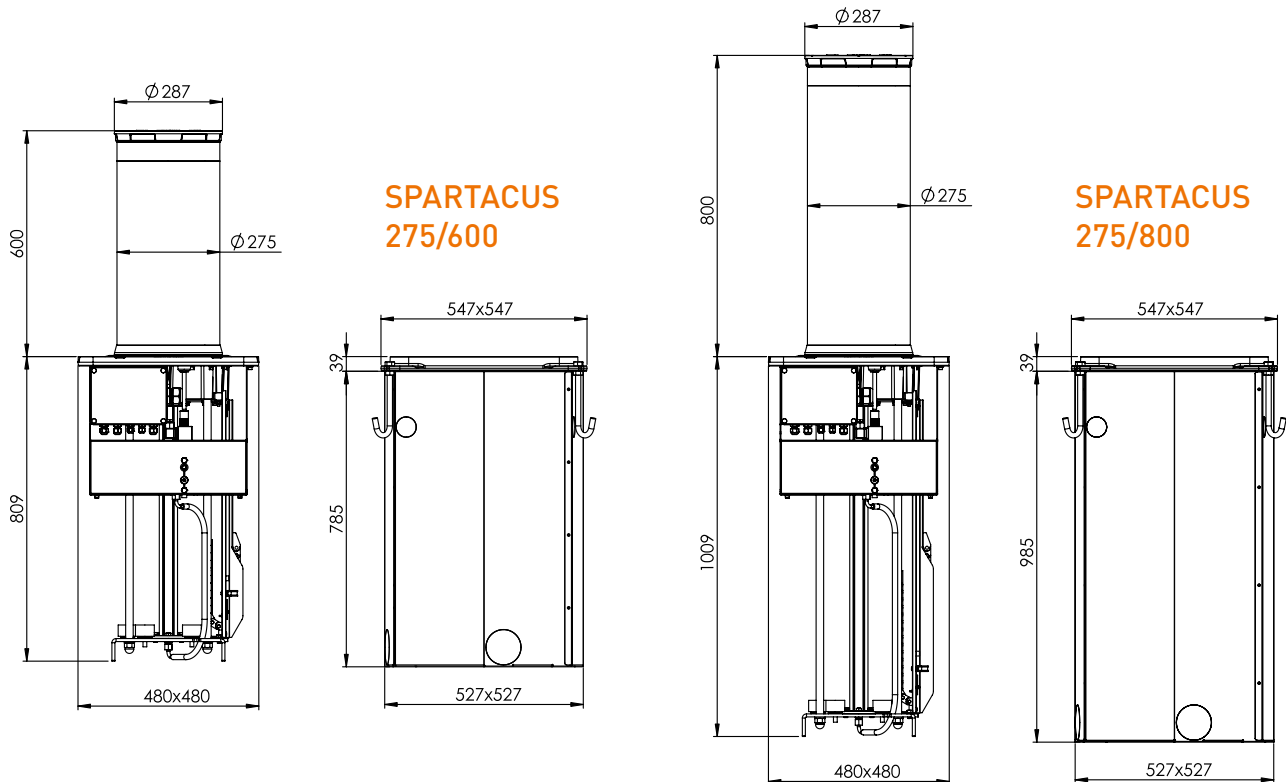

ACCESSORIES:

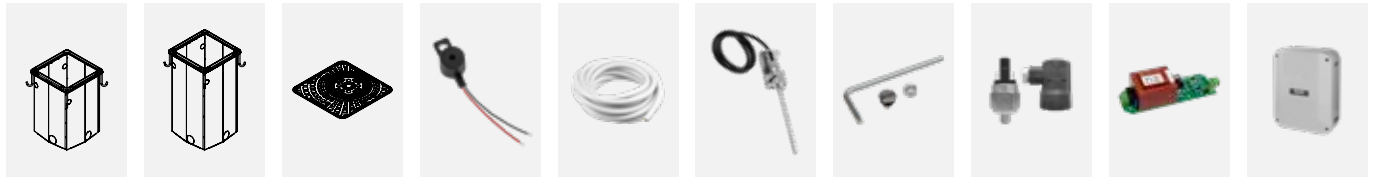

CA275/600	CA275/800	GL.TOP275	GL.BUZZ	GL.CABLE12	GL.HEAT	GL.PKEY	GL.PRES	GL.AL	XLB.AL
Foundation box for SPARTACUS 275 h 600 mm.	Foundation box for SPARTACUS 275 h 800 mm.	Cover for foundation box CA275/600 or CA275/800.	Buzzer.	Cable FG12 12x1.5 mmq. GL.CABLE16 Cable FG16 16x1.5 mmq.	Heater for hydraulic bollard, active below 5°C.	Personalised release key.	Pressure switch for obstacle detection.	Device that allows an automatic lowering maneuver.	Box for up to 4 GL.AL.

TECHNICAL DATA	275/600	275/600 AL	275/800	275/600 I	275/600 I AL	275/800 I	275/600 R	275/800 R	275/600 RI	275/800 RI
Cylinder height	600 mm		800 mm	600 mm		800 mm	600 mm	800 mm	600 mm	800 mm
Cylinder diameter	275 mm									
Cylinder thickness	6 mm			6+1.2 mm			10 mm		10+1.2 mm	
Cylinder material	Steel S355JR			AISI316 stainless steel			Steel S355JR		AISI316 stainless steel	
Rising time	3 s		4 s	3 s		4 s	3 s	4 s	3 s	4 s
Lowering time	3 s		4 s	3 s		4 s	3 s	4 s	3 s	4 s
Power supply	230 Vac - 50/60 Hz (control panel with different voltages available on request)									
Power consumption	550W									
Hydraulic pump	Built-in									
Load index (EN124)	D400 (40 tonnes)									
Operation in case of power failure	Manual release									
Automatic lowering in case of power failure	No	Yes (with GL.AL)	No	Yes (with GL.AL)			No			
Obstacle detection during the rising cycle	Optional (GL.PRES)									
Capacitor	25 µF									
Daily cycles	3,500									
MCBF	3,000,000									
Impact resistance	40,000 J					60,000 J				
Breakout resistance	250,000 J					400,000 J				
Operating temperature	-40°C ÷ +60°C [GL.HEAT available as option for temperatures lower than -10°]									
Protection level	IP67									
Weight (without foundation box)	94 kg	94 kg	105 kg	99 kg	99 kg	112 kg	109 kg	124 kg	114 kg	131 kg



SPARTACUS SA

∅ 200-275 mm | H 600 mm | Thickness 6 mm



- Semi-automatic bollard, 600 mm height, with cylinder thickness 6 mm
- Cathaphoresis treatment and “Graphite Black” painting or cover in brushed AISI316 stainless steel
- Cylinder with built-in LED lights in “L” versions
- Foundation box complying with the EN124 (25T SPARTACUS 200 SA, 40T SPARTACUS 275 SA)

SPARTACUS 200 SA

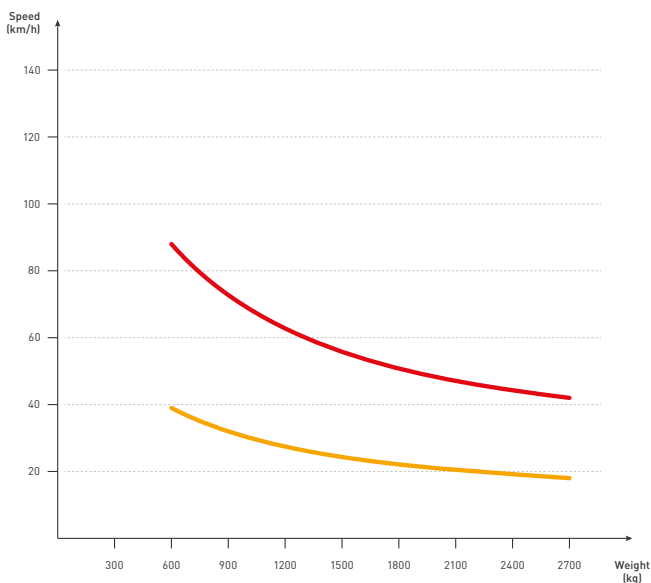

— Impact resistance: 35,000 J
— Breakout resistance: 150,000 J

SPARTACUS 275 SA

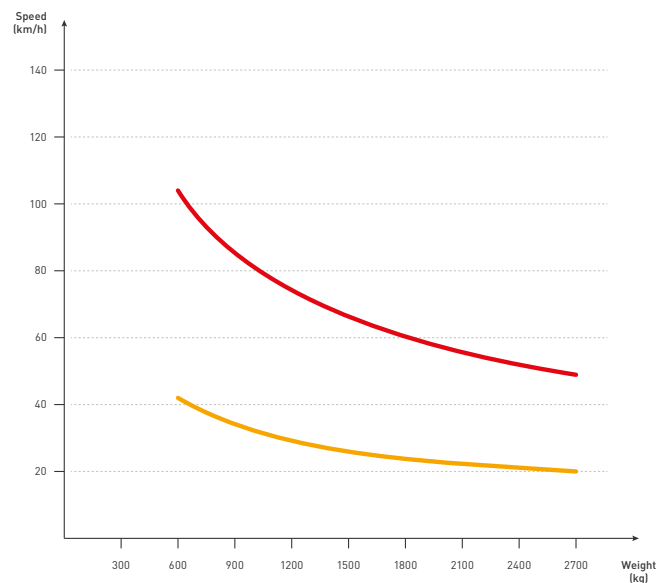

— Impact resistance: 40,000 J
— Breakout resistance: 250,000 J

SPARTACUS SA

ø 200-275 mm | H 600 mm | Thickness 6 mm

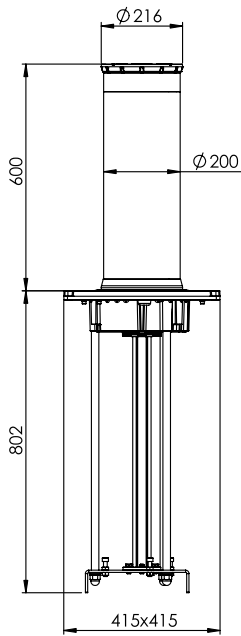

**SPARTACUS
200/600 SA**

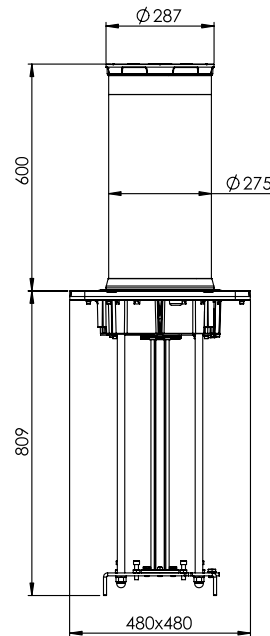
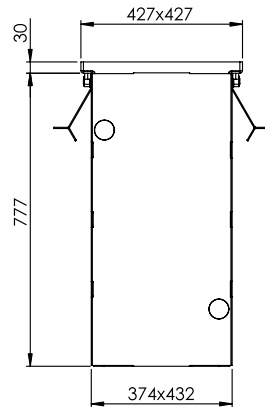

**SPARTACUS
275/600 SA**

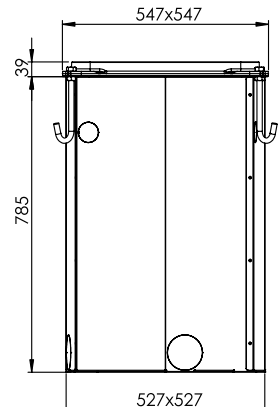

ACCESSORIES:

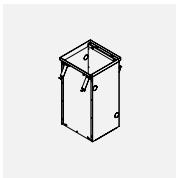

CA200/600

Foundation box for SPARTACUS 200 h 600 mm.

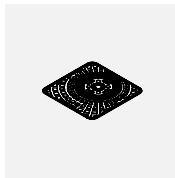

GL.TOP200

Cover for foundation box CA200/600.

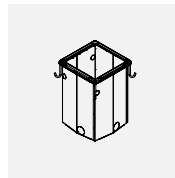

CA275/600

Foundation box for SPARTACUS 275 h 600 mm.

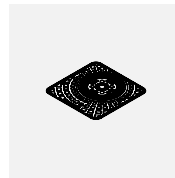

GL.TOP275

Cover for foundation box CA275/600.



GL.FL

Power supply for SPARTACUS SA/F lights.

TECHNICAL DATA	200/600 SA	200/600 SA L	200/600 SA I	200/600 SA IL	275/600 SA	275/600 SA L	275/600 I	275/600 SA IL
Cylinder height	600 mm							
Cylinder diameter	200 mm				275 mm			
Cylinder thickness	6 mm		6+1,2 mm		6 mm		6+1,2 mm	
Cylinder material	Steel S355JR		AISI316 stainless steel		Steel S355JR		AISI316 stainless steel	
Lights power supply	---	24 Vdc	---	24 Vdc	---	24 Vdc	---	24 Vdc
Load index (EN124)	D250 (25 tonnes)				D400 (40 tonnes)			
Impact resistance	35.000 J				40.000 J			
Breakout resistance	150.000 J				250.000 J			
Weight (without foundation box)	65 kg	65 kg	69 kg	69 kg	89 kg	89 kg	94 kg	94 kg



SPARTACUS F

∅ 200-275 mm | H 600-800 mm | Thickness 6 mm



- Fixed bollard, 600 or 800 mm height, with cylinder thickness 6 mm
- Cathaphoresis treatment and “Graphite Black” painting or cover in brushed AISI316 stainless steel
- Cylinder with built-in LED lights in “L” versions
- Foundation box complying with the EN124 (25T SPARTACUS 200 F, 40T SPARTACUS 275 F)

SPARTACUS 200 F

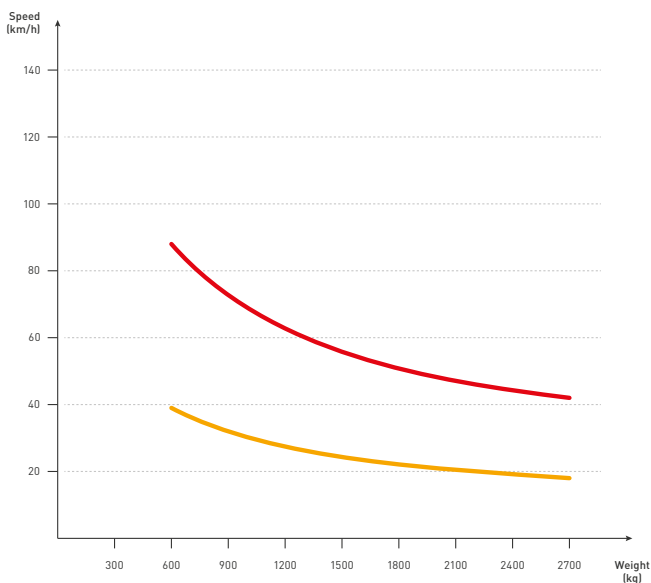

- Impact resistance: 35,000 J
- Breakout resistance: 150,000 J

SPARTACUS 275 F

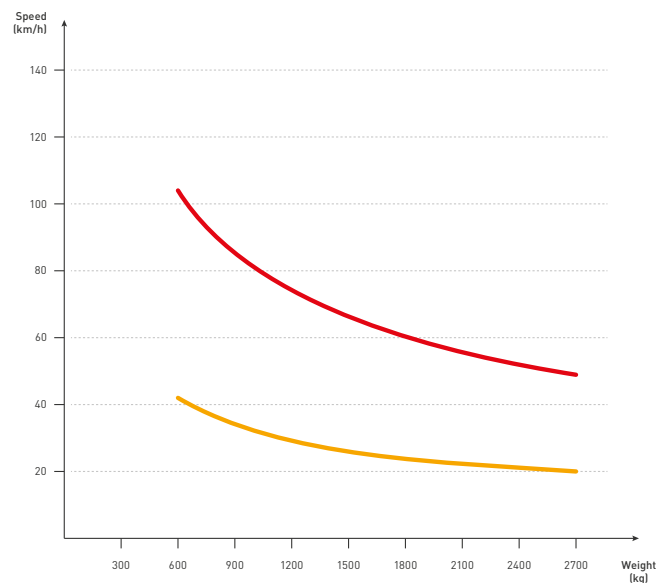

- Impact resistance: 40,000 J
- Breakout resistance: 250,000 J

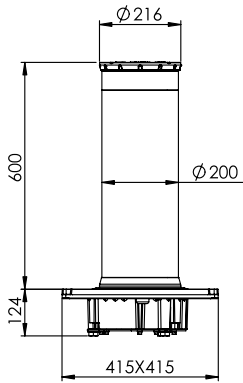

**SPARTACUS
200/600 F**

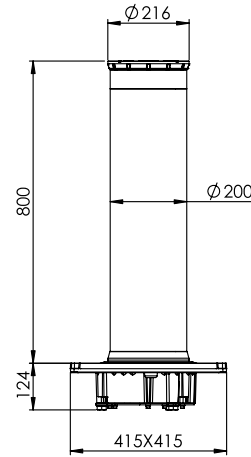
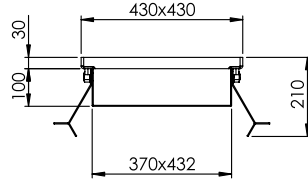

**SPARTACUS
200/800 F**

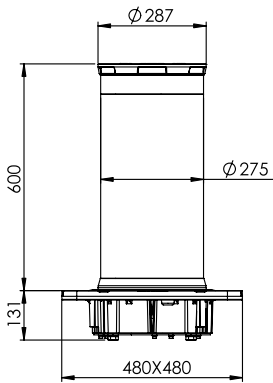
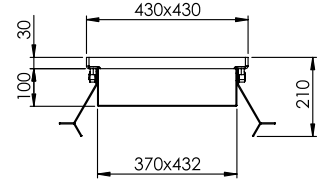

**SPARTACUS
275/600 F**

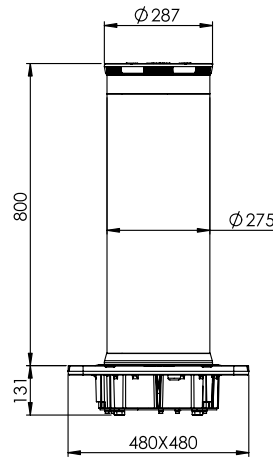
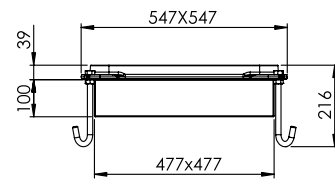

**SPARTACUS
275/800 F**

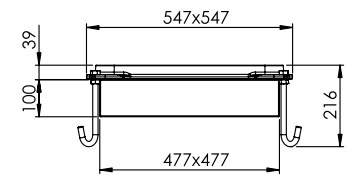

ACCESSORIES:

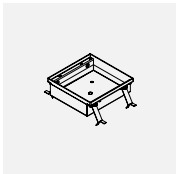

CA200F
Foundation box for
SPARTACUS 200 F.

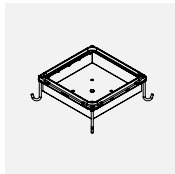

CA275F
Foundation box for
SPARTACUS 275 F.



GL.FL
Power supply for
SPARTACUS SA/F
lights.

TECHNICAL DATA	200/600 F	200/800 F	200/600 FI	200/800 FI	200/600 FL	200/800 FL	200/600 FIL	200/800 FIL
Cylinder height	600 mm	800 mm	600 mm	800 mm	600 mm	800 mm	600 mm	800 mm
Cylinder diameter	200 mm							
Cylinder thickness	6 mm		6+1,2 mm		6 mm		6+1,2 mm	
Cylinder material	Steel S355JR		AISI316 stainless steel		Steel S355JR		AISI316 stainless steel	
Lights power supply	---				24 Vdc			
Impact resistance	35.000 J							
Breakout resistance	150.000 J							
Weight (without foundation box)	44 kg	52 kg	49 kg	59 kg	44 kg	52 kg	49 kg	59 kg

TECHNICAL DATA	275/600 F	275/800 F	275/600 FI	275/800 FI	275/600 FL	275/800 FL	275/600 FIL	275/800 FIL
Cylinder height	600 mm	800 mm	600 mm	800 mm	600 mm	800 mm	600 mm	800 mm
Cylinder diameter	275 mm							
Cylinder thickness	6 mm		6+1,2 mm		6 mm		6+1,2 mm	
Cylinder material	Steel S355JR		AISI316 stainless steel		Steel S355JR		AISI316 stainless steel	
Lights power supply	---				24 Vdc			
Impact resistance	40.000 J							
Breakout resistance	250.000 J							
Weight (without foundation box)	60 kg	68 kg	65 kg	75 kg	60 kg	68 kg	65 kg	75 kg



MAX.CP BL

Control panel for 2 hydraulic bollards

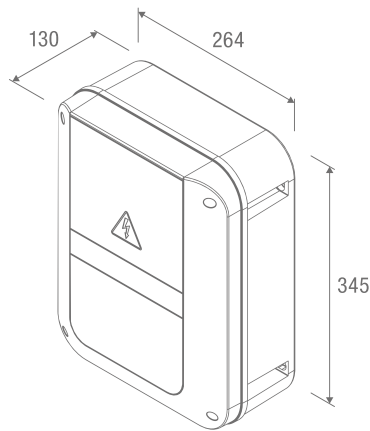

- 230 Vac 50/60 Hz power supply
- Control panel for 1 or 2 hydraulic bollards SPARTACUS
- Integrated 433.92 MHz 64-code receiver with 3 encoding systems (Advanced Rolling Code, Rolling Code, Fixed Code)
- Removable terminal boards
- Parameter and operation logic regulations through integrated LCD display
- Automatic, semi-automatic and deadman's logic
- Programming access password
- Equipped with step-by-step command inputs separate for each bollard and centralised command inputs ALL UP and ALL DOWN for the raising and the lowering of both bollards
- Built-in board to manage buzzer/LED lights
- Separate limit switch inputs for each motor
- Control inputs for loop detectors and protection devices (GL.PRES)
- 2 outputs configurable as bollard status indicator
- Protection level IP54

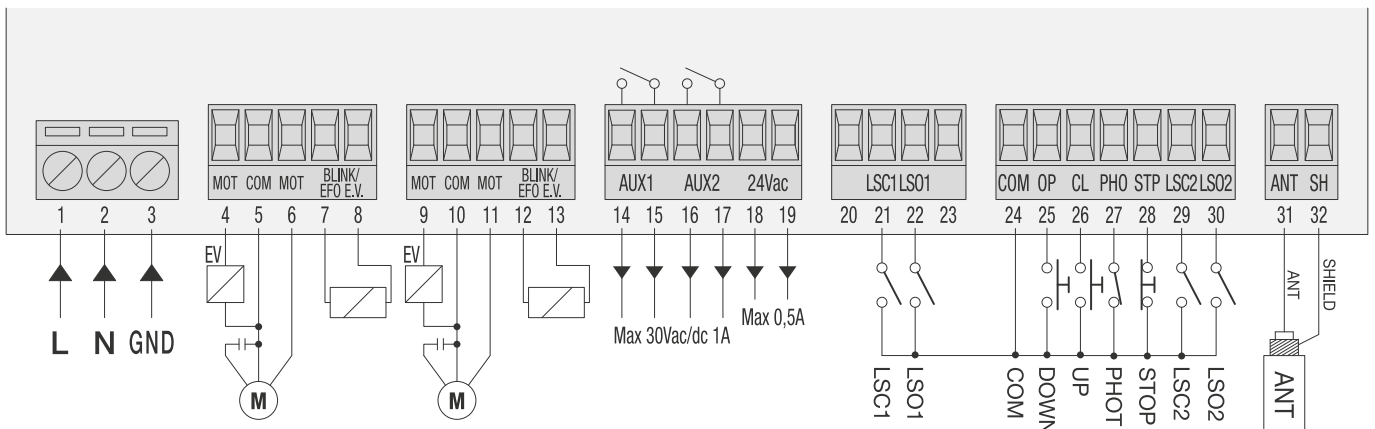

CALCULATION OF THE BOLLARD NUMBER PER PASSAGE:

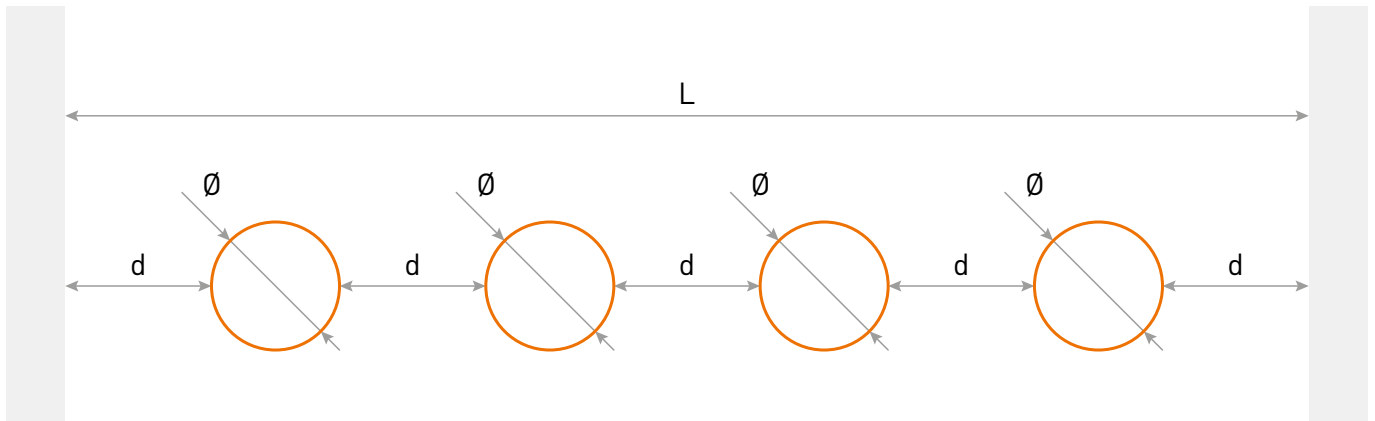

$$N = \frac{L - d_{\text{recommended}}}{\text{Ø} + d_{\text{recommended}}}$$

L (mm) = width of the passage for the vehicles access

N = number of necessary bollards

Ø (mm) = bollards diameter

$$d = \frac{L - (\text{Ø} \cdot N)}{N + 1}$$

d (mm) = distance between bollards

$d_{\text{recommended}}$ (mm) = recommended distance between bollards (1.200 mm)





RISE Srl

Sede legale:

Via del Capitello, 45
36066 Sandrigo (VI) ITALIA

Sede operativa:

Via della Tecnica, 10
36010 Velo d'Astico (VI) ITALIA

T +39 0444 751401

C.F. / P.IVA (IT) 03482500240

info@riseweb.it
www.riseweb.it

