

230_{VAC}24_{VDC}

BOB2124.DK

BOB3024E.DK

**CONTROL UNITS:**

BOB2124.DK

- BRAINY24^{PLUS} 148
- BRAINY24 149
- TRUST24 150

BOB3024E.DK

- BRAINY24^{PLUS} 148
- BRAINY24 149
- TRUST24 150

LINEAR WORM SCREWS



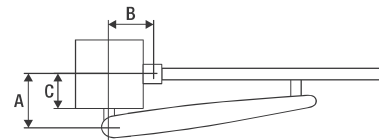
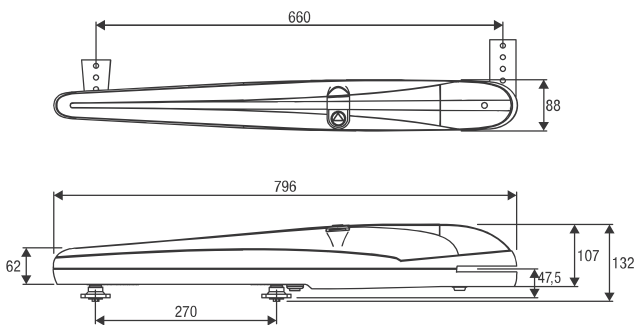

adjustable mechanical stops in opening and closing
 patented FACE gears
 bronze release wheel
 BOB3024E.DK: bronze screwdriver

up to 3.0 m**24 Vdc | intensive use**

- Irreversible electromechanical 24 Vdc gear motor for intensive use, also available with encoder (BOB3024E.DK)
- The TRUST24 control unit ensures power consumption in standby mode of < 0.8 W
- Amperometric sensor obstacle detection system to prevent crushing
- Reliable, quiet, and quick to install geared motor, thanks to its 2 adjustable mechanical stops for opening and closing
- Easy-access top release with customised key (BOB3024E.DK)
- Optional battery powered operation
- Easy to install thanks to the included screw-on brackets



A (mm)	B (mm)	C (mm)
105-135	115-135	50-80

COMPLETE KITS	 MOTORS	 CONTROL UNIT	 PHOTOCELLS	 FLASHING LIGHT	 TRANSMITTER
KBOB2124.DK	2x BOB2124.DK	1x TRUST24	1x PUPILLA.T	1x LAMPY	1x TO.GO2VA
KBOB3024E.DK	2x BOB3024E.DK	1x TRUST24	1x PUPILLA.T	1x LAMPY	1x TO.GO2VA

**BOB.SN**

Rear joint for sloping openings.

**DU.V96**

12 Vac/dc vertical electric lock, supplied with counterplate. Permits internal/external release.

**DU.V90**

12 Vac/dc horizontal electric lock, supplied with counterplate. Permits internal/external release.

**DU.9990**

Covering plate for DU.V90.

**E.LOCK**

230 Vac vertical electric lock, supplied with counterplate.

**E.LOCKSE**

Extended cylinder for E.LOCK electric lock. It allows unlocking gates up to 55mm-thick from the outside.

**CABLE.24E**

Cable reel with 5 conductors (2 for motor, 3 for encoder) for connecting the encoder device in the 24 Vdc versions. L= 100 m.

**XLB.CB**

Battery box fitted with universal bracket and cables. IP54.

**DA.LB**

Galvanized column for outdoor installation of LB box.

**BRAINY24.CB-SW**

Accessory equipped with 1.2 Ah batteries and support bracket.

**BRAINY24.CB**

Accessory with CBY.24V battery charger, 1.2 Ah batteries and support bracket.

TECHNICAL DATA	BOB2124.DK*	BOB3024E.DK*
Motor supply	24 Vdc	24 Vdc
Max absorbed current	5,5 A	5,5 A
Max Thrust	1500 N	1500 N
Opening time	12"	12"
Duty cycle	intensive use	intensive use
Standard stroke	270 mm	270 mm
Max stroke	325 mm	325 mm
Protection level	IP44	IP44
Encoder	NO	YES
Operating temperature	-20°C /+50°C	-20°C /+50°C
Leaf max dimension	2,1 m	3 m
Weight	6,4 kg	6,7 kg
Items no. per pallet	50	50
Kit weight	14,7 kg	15,3 kg
Kits no. per pallet	18	18

* Available in 115 VAC version